

Řemenice pro klínové řemeny

Profil **SPB - B - 5V**

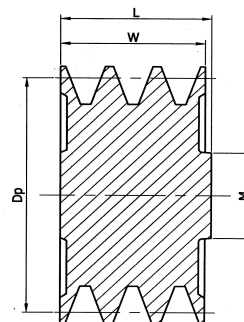

P

SPB - B - 5V						
Označení řemenice	Roztečný průměr Dp (mm)	Počet drážek	Typ	Průměr náboje M (mm)	Šíře věnce W (mm)	Celková šíře řemenice L (mm)
PT 1 SPB 60	60	1	P	40	25	35
PT 2 SPB 60		2	P	40	44	48
PT 1 SPB 71	71	1	P	45	25	35
PT 2 SPB 71		2	P	45	44	48
PT 3 SPB 71		3	P	45	63	67
PT 1 SPB 75	75	1	P	45	25	35
PT 2 SPB 75		2	P	45	44	48
PT 3 SPB 75		3	P	45	63	67
PT 1 SPB 80	80	1	P	50	25	35
PT 2 SPB 80		2	P	50	44	48
PT 3 SPB 80		3	P	50	63	67
PT 4 SPB 80		4	P	52	82	86
PT 5 SPB 80		5	P	58	101	105
PT 1 SPB 85	85	1	P	50	25	35
PT 2 SPB 85		2	P	50	44	48
PT 3 SPB 85		3	P	52	63	67
PT 4 SPB 85		4	P	58	82	86
PT 5 SPB 85		5	P	58	101	105
PT 1 SPB 90	90	1	P	50	25	35
PT 2 SPB 90		2	P	50	44	48
PT 3 SPB 90		3	P	58	63	67
PT 4 SPB 90		4	P	65	82	50
PT 5 SPB 90		5	P	65	101	50
PT 1 SPB 95	95	1	P	52	25	35
PT 2 SPB 95		2	P	55	44	48
PT 3 SPB 95		3	P	58	63	67
PT 4 SPB 95		4	P	65	82	50
PT 5 SPB 95		5	P	65	101	50
PT 1 SPB 100	100	1	P	52	25	35
PT 2 SPB 100		2	P	55	44	48
PT 3 SPB 100		3	P	58	63	67
PT 4 SPB 100		4	P	65	82	50
PT 5 SPB 100		5	P	65	101	50

Příklad označení - vzor objednávky: Řemenice klínová **PT 1 SPB 95**

Řemenice pro klínové řemeny

Profil SPB - B - 5V

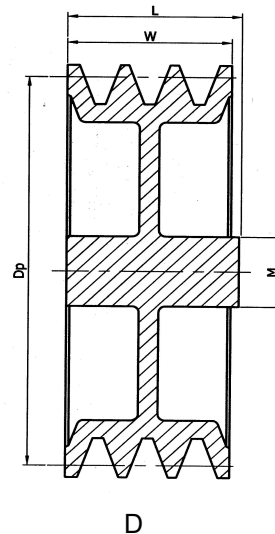
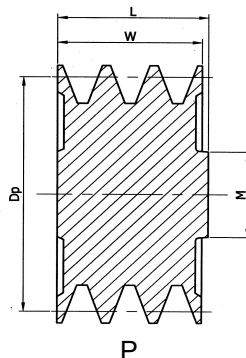

SPB - B - 5V						
Označení řemenice	Roztečný průměr Dp (mm)	Počet drážek	Typ	Průměr náboje M (mm)	Šíře věnce W (mm)	Celková šíře řemenice L (mm)
PT 1 SPB 106	106	1	P	50	25	35
PT 2 SPB 106		2	P	55	44	48
PT 3 SPB 106		3	P	65	63	50
PT 4 SPB 106		4	P	65	82	50
PT 5 SPB 106		5	P	67	101	50
PT 1 SPB 112	112	1	D	55	25	35
PT 2 SPB 112		2	D	60	44	48
PT 3 SPB 112		3	P	65	63	50
PT 4 SPB 112		4	P	75	82	50
PT 5 SPB 112		5	P	75	101	50
PT 1 SPB 118	118	1	D	55	25	35
PT 2 SPB 118		2	D	60	44	48
PT 3 SPB 118		3	P	75	63	50
PT 4 SPB 118		4	P	75	82	50
PT 5 SPB 118		5	P	75	101	50
PT 1 SPB 125	125	1	D	55	25	35
PT 2 SPB 125		2	D	60	44	48
PT 3 SPB 125		3	D	75	63	50
PT 4 SPB 125		4	D	75	82	50
PT 5 SPB 125		5	D	75	101	50
PT 6 SPB 125		6	P	80	120	60
PT 1 SPB 132	132	1	D	60	25	35
PT 2 SPB 132		2	D	60	44	50
PT 3 SPB 132		3	D	75	63	50
PT 4 SPB 132		4	D	80	82	50
PT 5 SPB 132		5	D	80	101	60
PT 6 SPB 132		6	D	80	120	60
PT 1 SPB 140	140	1	D	60	25	35
PT 2 SPB 140		2	D	65	44	50
PT 3 SPB 140		3	D	75	63	50
PT 4 SPB 140		4	D	80	82	50
PT 5 SPB 140		5	D	80	101	60
PT 6 SPB 140		6	D	80	120	60

Příklad označení - vzor objednávky: Řemenice klínová **PT 1 SPB 95**

Řemenice pro klínové řemeny

Profil SPB - B - 5V

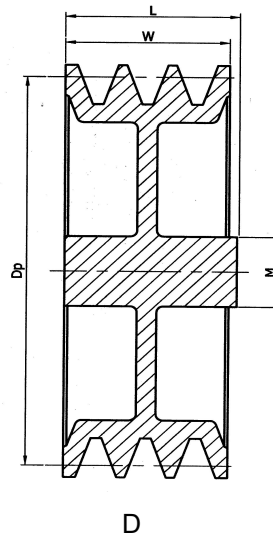

SPB - B - 5V						
Označení řemenice	Roztečný průměr Dp (mm)	Počet drážek	Typ	Průměr náboje M (mm)	Šíře věnce W (mm)	Celková šíře řemenice L (mm)
PT 1 SPB 150	150	1	D	60	25	40
PT 2 SPB 150		2	D	65	44	50
PT 3 SPB 150		3	D	75	63	50
PT 4 SPB 150		4	D	80	82	50
PT 5 SPB 150		5	D	80	101	60
PT 6 SPB 150		6	D	88	120	60
PT 1 SPB 160	160	1	D	65	25	40
PT 2 SPB 160		2	D	68	44	50
PT 3 SPB 160		3	D	80	63	50
PT 4 SPB 160		4	D	88	82	60
PT 5 SPB 160		5	D	88	101	60
PT 6 SPB 160		6	D	88	120	65
PT 1 SPB 170	170	1	D	65	25	40
PT 2 SPB 170		2	D	68	44	50
PT 3 SPB 170		3	D	80	63	50
PT 4 SPB 170		4	D	88	82	60
PT 5 SPB 170		5	D	88	101	60
PT 6 SPB 170		6	D	104	120	65
PT 1 SPB 180	180	1	D	65	25	40
PT 2 SPB 180		2	D	68	44	50
PT 3 SPB 180		3	D	80	63	50
PT 4 SPB 180		4	D	88	82	60
PT 5 SPB 180		5	D	88	101	70
PT 6 SPB 180		6	D	104	120	70
PT 1 SPB 190	190	1	D	65	25	40
PT 2 SPB 190		2	D	68	44	50
PT 3 SPB 190		3	D	80	63	50
PT 4 SPB 190		4	D	88	82	60
PT 5 SPB 190		5	D	88	101	70
PT 6 SPB 190		6	D	104	120	70
PT 1 SPB 200	200	1	D	68	25	40
PT 2 SPB 200		2	D	68	44	50
PT 3 SPB 200		3	D	80	63	50
PT 4 SPB 200		4	D	88	82	60
PT 5 SPB 200		5	D	88	101	70
PT 6 SPB 200		6	D	104	120	80

Příklad označení - vzor objednávky: Řemenice klínová PT 1 SPB 95

Řemenice pro klínové řemeny

Profil SPB - B - 5V

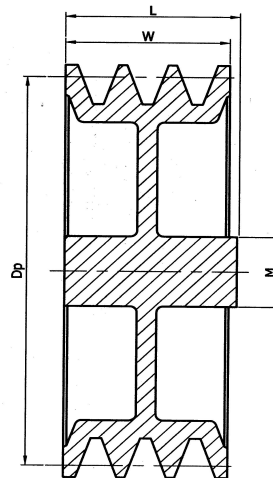

D

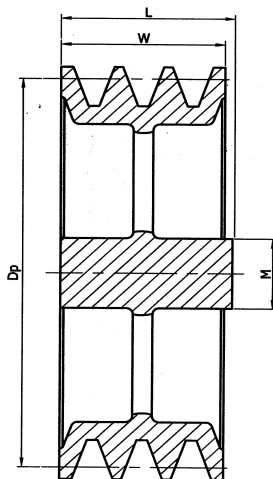

R

SPB - B - 5V						
Označení řemenice	Roztečný průměr Dp (mm)	Počet drážek	Typ	Průměr náboje M (mm)	Šíře věnce W (mm)	Celková šíře řemenice L (mm)
PT 1 SPB 212	212	1	D	68	25	45
PT 2 SPB 212		2	D	68	44	50
PT 3 SPB 212		3	D	80	63	50
PT 4 SPB 212		4	D	88	82	60
PT 5 SPB 212		5	D	88	101	70
PT 6 SPB 212		6	D	104	120	80
PT 1 SPB 224	224	1	D	68	25	45
PT 2 SPB 224		2	D	75	44	50
PT 3 SPB 224		3	D	80	63	50
PT 4 SPB 224		4	D	88	82	60
PT 5 SPB 224		5	D	96	101	70
PT 6 SPB 224		6	D	104	120	80
PT 1 SPB 236	236	1	D	68	25	45
PT 2 SPB 236		2	D	75	44	50
PT 3 SPB 236		3	D	80	63	60
PT 4 SPB 236		4	D	88	82	65
PT 5 SPB 236		5	D	96	101	75
PT 6 SPB 236		6	D	104	120	80
PT 1 SPB 250	250	1	R	70	25	45
PT 2 SPB 250		2	R	75	44	50
PT 3 SPB 250		3	R	88	63	60
PT 4 SPB 250		4	R	96	82	65
PT 5 SPB 250		5	D	104	101	75
PT 6 SPB 250		6	D	104	120	80
PT 1 SPB 280	280	1	R	75	25	45
PT 2 SPB 280		2	R	75	44	50
PT 3 SPB 280		3	R	88	63	60
PT 4 SPB 280		4	R	96	82	65
PT 5 SPB 280		5	R	104	101	75
PT 6 SPB 280		6	R	104	120	80
PT 1 SPB 300	300	1	R	75	25	50
PT 2 SPB 300		2	R	80	44	50
PT 3 SPB 300		3	R	88	63	60
PT 4 SPB 300		4	R	96	82	65
PT 5 SPB 300		5	R	104	101	75
PT 6 SPB 300		6	R	104	120	80

Příklad označení - vzor objednávky: Řemenice klínová PT 1 SPB 95

Řemenice pro klínové řemeny

Profil **SPB - B - 5V**

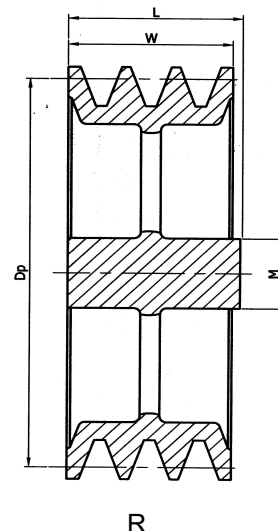

SPB - B - 5V						
Označení řemenice	Roztečný průměr Dp (mm)	Počet drážek	Typ	Průměr náboje M (mm)	Šíře věnce W (mm)	Celková šíře řemenice L (mm)
PT 2 SPB 315	315	2	R	88	44	60
PT 3 SPB 315		3	R	88	63	60
PT 4 SPB 315		4	R	96	82	65
PT 5 SPB 315		5	R	104	101	75
PT 6 SPB 315		6	R	120	120	90
PT 2 SPB 355	355	2	R	88	44	60
PT 3 SPB 355		3	R	96	63	60
PT 4 SPB 355		4	R	96	82	65
PT 5 SPB 355		5	R	104	101	75
PT 6 SPB 355		6	R	120	120	90
PT 2 SPB 400	400	2	R	88	44	60
PT 3 SPB 400		3	R	96	63	65
PT 4 SPB 400		4	R	104	82	75
PT 5 SPB 400		5	R	112	101	85
PT 6 SPB 400		6	R	120	120	100
PT 2 SPB 450	450	2	R	88	44	60
PT 3 SPB 450		3	R	96	63	65
PT 4 SPB 450		4	R	104	82	75
PT 5 SPB 450		5	R	112	101	85
PT 6 SPB 450		6	R	120	120	100
PT 2 SPB 500	500	2	R	96	44	65
PT 3 SPB 500		3	R	104	63	75
PT 4 SPB 500		4	R	112	82	85
PT 5 SPB 500		5	R	120	101	90
PT 6 SPB 500		6	R	128	120	105
PT 2 SPB 560	560	2	R	96	44	65
PT 3 SPB 560		3	R	104	63	75
PT 4 SPB 560		4	R	112	82	85
PT 5 SPB 560		5	R	120	101	90
PT 6 SPB 560		6	R	128	120	105
PT 2 SPB 630	630	2	R	104	44	75
PT 3 SPB 630		3	R	120	63	90
PT 4 SPB 630		4	R	128	82	105
PT 5 SPB 630		5	R	145	101	115
PT 6 SPB 630		6	R	145	120	115

Příklad označení - vzor objednávky: Řemenice klínová **PT 1 SPB 95**

Řemenice pro klínové řemeny

Profil **SPB - B - 5V**

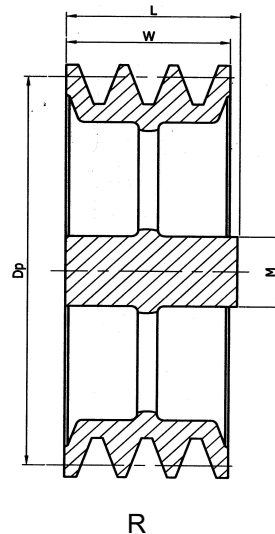

SPB - B - 5V						
Označení řemenice	Roztečný průměr Dp (mm)	Počet drážek	Typ	Průměr náboje M (mm)	Šíře věnce W (mm)	Celková šíře řemenice L (mm)
PT 2 SPB 710	710	2	R	96	44	65
PT 3 SPB 710		3	R	112	63	75
PT 4 SPB 710		4	R	120	82	90
PT 5 SPB 710		5	R	128	101	105
PT 6 SPB 710		6	R	145	120	115
PT 2 SPB 800	800	2	R	104	44	70
PT 3 SPB 800		3	R	120	63	90
PT 4 SPB 800		4	R	128	82	105
PT 5 SPB 800		5	R	145	101	115
PT 6 SPB 800		6	R	145	120	115

Příklad označení - vzor objednávky: Řemenice klínová **PT 1 SPB 95**

Řemenice pro klínové řemeny

Profil SPB - B - 5V

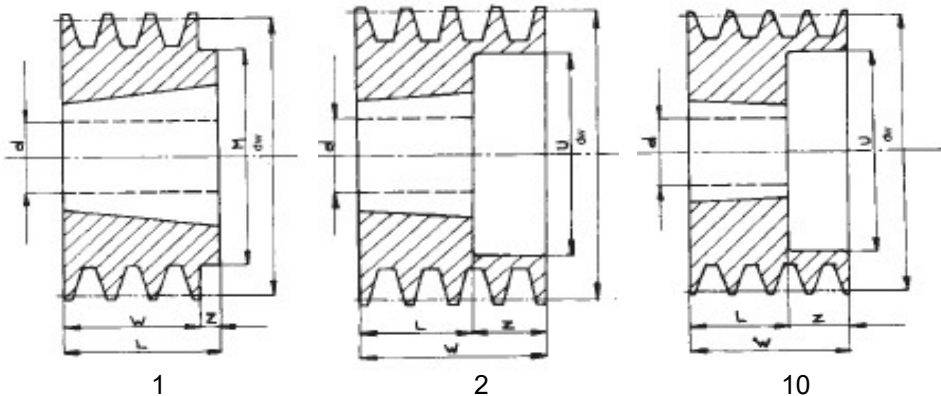
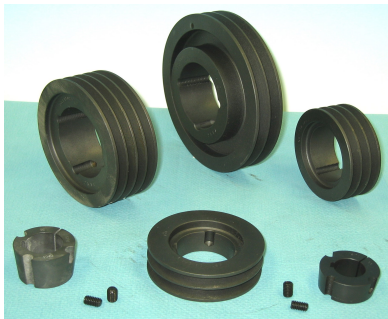

SPB - B - 5V								
Označení řemenice	Roztečný průměr d_w (mm)	Počet drážek	Typ	Pouzdro Taper Lock	Šířka věnce W (mm)	Vnitřní průměr věnce U (mm)	Šířka náboje L (mm)	Průměr náboje M (mm)
PBT 1 SPB 90	90	1	1	1210	25	-	25	-
PBT 2 SPB 90		2	10	1210	44	47	25	-
PBT 3 SPB 90		3	10	1210	63	47	25	-
PBT 1 SPB 100	100	1	2	1610	25	-	25	-
PBT 2 SPB 100		2	10	1610	44	60	25	-
PBT 3 SPB 100		3	10	1610	63	57	25	-
PBT 1 SPB 112	112	1	2	1610	25	-	25	-
PBT 2 SPB 112		2	10	1610	44	69	25	-
PBT 3 SPB 112		3	10	1610	63	69	25	-
PBT 1 SPB 118	118	1	2	1610	25	-	25	-
PBT 2 SPB 118		2	10	1610	44	76	25	-
PBT 3 SPB 118		3	10	1610	63	76	25	-
PBT 1 SPB 125	125	1	2	1610	25	-	25	-
PBT 2 SPB 125		2	2	2012	44	86	32	-
PBT 3 SPB 125		3	2	2012	63	86	32	-
PBT 4 SPB 125		4	11	2012	82	86	32	-
PBT 1 SPB 132	132	1	2	1610	25	-	25	-
PBT 2 SPB 132		2	2	2012	44	89	32	-
PBT 3 SPB 132		3	2	2012	63	89	32	-
PBT 4 SPB 132		4	11	2012	82	89	32	-
PBT 1 SPB 140	140	1	1	1610	25	-	25	-
PBT 2 SPB 140		2	2	2012	44	100	31	-
PBT 3 SPB 140		3	2	2012	63	100	31	-
PBT 4 SPB 140		4	11	2517	82	100	46	-
PBT 5 SPB 140		5	11	2517	101	100	46	-
PBT 6 SPB 140		6	11	2517	120	100	46	-
PBT 1 SPB 150	150	1	1	1610	25	-	25	-
PBT 2 SPB 150		2	2	2012	44	110	31	-
PBT 3 SPB 150		3	2	2517	63	110	46	-
PBT 4 SPB 150		4	11	2517	82	110	46	-
PBT 5 SPB 150		5	11	2517	101	110	46	-
PBT 6 SPB 150		6	11	2517	120	110	46	-

Příklad označení - vzor objednávky: Řemenice klínová **PBT 1 SPB 150 - 1610 TL**

Řemenice pro klínové řemeny

Profil SPB - B - 5V

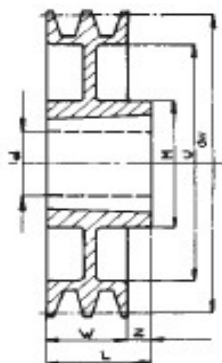

4

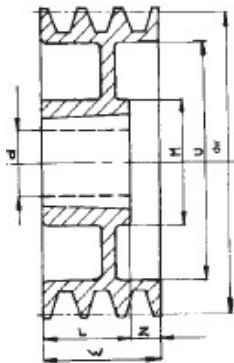

5

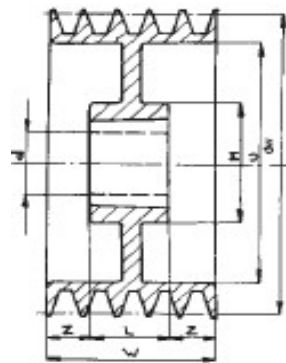

6

SPB - B - 5V

Označení řemenice	Roztečný průměr dw (mm)	Počet drážek	Typ	Pouzdro Taper Lock	Šířka věnce W (mm)	Vnitřní průměr věnce U (mm)	Šířka náboje L (mm)	Průměr náboje M (mm)
PBT 1 SPB 160	160	1	1	1610	25	-	25	-
PBT 2 SPB 160		2	2	2012	44	120	31	-
PBT 3 SPB 160		3	2	2517	63	120	46	-
PBT 4 SPB 160		4	11	2517	82	120	46	-
PBT 5 SPB 160		5	11	2517	101	120	46	-
PBT 6 SPB 160		6	11	3020	120	120	51	-
PBT 8 SPB 160		8	11	3020	158	120	51	-
PBT 1 SPB 170	170	1	1	1610	25	-	25	-
PBT 2 SPB 170		2	2	2012	44	130	31	-
PBT 3 SPB 170		3	2	2517	63	130	46	-
PBT 4 SPB 170		4	11	2517	82	130	46	-
PBT 5 SPB 170		5	11	3020	101	130	51	-
PBT 6 SPB 170		6	11	3020	120	130	51	-
PBT 8 SPB 170		8	11	3020	158	130	51	-
PBT 1 SPB 180	180	1	1	1610	25	-	25	-
PBT 2 SPB 180		2	4	2517	44	140	46	120
PBT 3 SPB 180		3	5	2517	63	140	46	120
PBT 4 SPB 180		4	6	2517	82	140	46	120
PBT 5 SPB 180		5	11	3020	101	140	51	-
PBT 6 SPB 180		6	11	3020	120	140	51	-
PBT 8 SPB 180		8	11	3020	158	140	51	-
PBT 1 SPB 190	190	1	4	2012	25	-	32	112
PBT 2 SPB 190		2	4	2517	44	150	46	120
PBT 3 SPB 190		3	5	2517	63	150	46	120
PBT 4 SPB 190		4	6	2517	82	150	46	120
PBT 5 SPB 190		5	11	3020	101	150	51	-
PBT 6 SPB 190		6	11	3020	120	150	51	-
PBT 8 SPB 190		8	11	3020	158	150	51	-
PBT 1 SPB 200	200	1	4	2012	25	-	32	112
PBT 2 SPB 200		2	4	2517	44	160	46	120
PBT 3 SPB 200		3	5	2517	63	160	46	120
PBT 4 SPB 200		4	6	3020	82	160	51	146
PBT 5 SPB 200		5	6	3020	101	160	51	146
PBT 6 SPB 200		6	6	3020	120	160	51	146
PBT 8 SPB 200		8	11	3535	158	160	91	-

Příklad označení - vzor objednávky: Řemenice klínová PBT 2 SPB 200 - 2517 TL

Řemenice pro klínové řemeny

Profil SPB - B - 5V

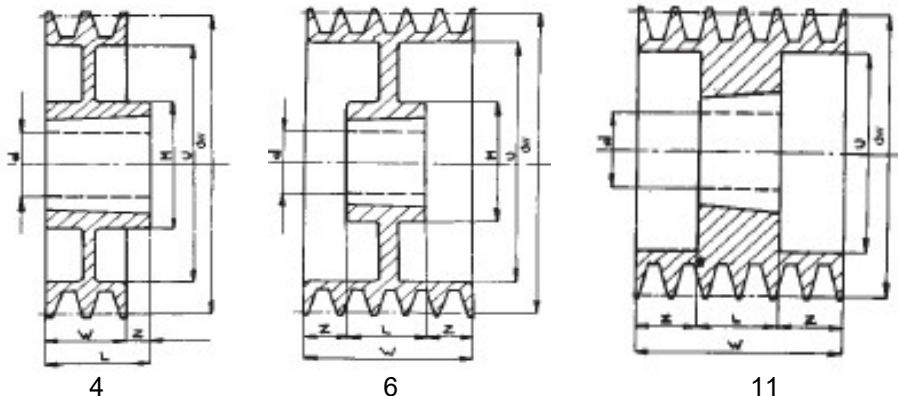

SPB - B - 5V								
Označení řemenice	Roztečný průměr dw (mm)	Počet drážek	Typ	Pouzdro Taper Lock	Šířka věnce W (mm)	Vnitřní průměr věnce U (mm)	Šířka náboje L (mm)	Průměr náboje M (mm)
PBT 2 SPB 212	212	2	4	2517	44	172	46	120
PBT 3 SPB 212		3	5	2517	63	172	46	120
PBT 4 SPB 212		4	6	3020	82	172	51	146
PBT 5 SPB 212		5	6	3020	101	172	51	146
PBT 6 SPB 212		6	11	3535	120	172	91	-
PBT 8 SPB 212		8	11	3535	158	172	91	-
PBT 2 SPB 224	224	2	4	2517	44	184	46	120
PBT 3 SPB 224		3	5	2517	63	184	46	120
PBT 4 SPB 224		4	6	3020	82	184	51	146
PBT 5 SPB 224		5	6	3020	101	184	51	146
PBT 6 SPB 224		6	11	3535	120	184	91	-
PBT 8 SPB 224		8	11	3535	158	184	91	-
PBT 2 SPB 236	236	2	4	2517	44	196	46	120
PBT 3 SPB 236		3	6	2517	63	196	46	120
PBT 4 SPB 236		4	6	3020	82	196	51	146
PBT 5 SPB 236		5	11	3535	101	196	91	178
PBT 6 SPB 236		6	11	3535	120	196	91	178
PBT 8 SPB 236		8	11	3535	158	196	91	178
PBT 2 SPB 250	250	2	4	2517	44	210	46	120
PBT 3 SPB 250		3	5	3020	63	210	51	146
PBT 4 SPB 250		4	6	3020	82	210	51	146
PBT 5 SPB 250		5	6	3535	101	210	91	178
PBT 6 SPB 250		6	6	3535	120	210	91	178
PBT 8 SPB 250		8	6	3535	158	210	91	178
PBT 2 SPB 280	280	2	4	2517	44	240	46	120
PBT 3 SPB 280		3	6	3020	63	240	51	146
PBT 4 SPB 280		4	6	3020	82	240	51	146
PBT 5 SPB 280		5	6	3535	101	240	91	178
PBT 6 SPB 280		6	6	3535	120	240	91	178
PBT 8 SPB 280		8	6	3535	158	240	91	178
PBT 2 SPB 300	300	2	4	2517	44	260	46	120
PBT 3 SPB 300		3	5	3020	63	260	51	146
PBT 4 SPB 300		4	4	3535	82	260	91	178
PBT 5 SPB 300		5	5	3535	101	260	91	178
PBT 6 SPB 300		6	5	3535	120	260	91	178
PBT 8 SPB 300		8	6	3535	158	260	91	178

Příklad označení - vzor objednávky: Řemenice klínová PBT 4 SPB 280 - 3020 TL

Řemenice pro klínové řemeny

Profil SPB - B - 5V

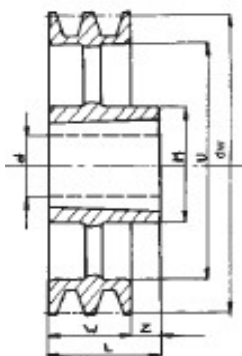

7

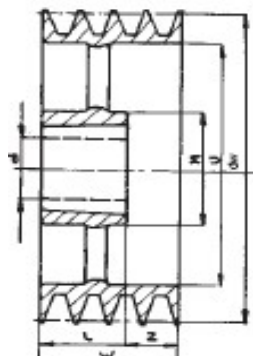

8

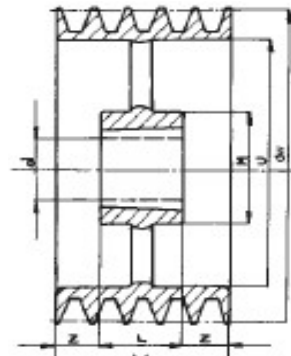

9

SPB - B - 5V

Označení řemenice	Roztečný průměr dw (mm)	Počet drážek	Typ	Pouzdro Taper Lock	Šířka věnce W (mm)	Vnitřní průměr věnce U (mm)	Šířka náboje L (mm)	Průměr náboje M (mm)
PBT 2 SPB 315	315	2	12	2517	44	275	46	120
PBT 3 SPB 315		3	6	3020	63	275	51	146
PBT 4 SPB 315		4	4	3535	82	275	91	178
PBT 5 SPB 315		5	5	3535	101	275	91	178
PBT 6 SPB 315		6	6	3535	120	275	91	178
PBT 8 SPB 315		8	6	3535	158	275	91	178
PBT 2 SPB 355	355	2	3	3020	44	315	51	146
PBT 3 SPB 355		3	9	3020	63	315	51	146
PBT 4 SPB 355		4	7	3535	82	315	91	178
PBT 5 SPB 355		5	8	3535	101	315	91	178
PBT 6 SPB 355		6	8	3535	120	315	91	178
PBT 8 SPB 355		8	9	3535	158	315	91	178
PBT 2 SPB 400	400	2	3	3020	44	360	51	146
PBT 3 SPB 400		3	7	3535	63	360	91	178
PBT 4 SPB 400		4	7	3535	82	360	91	178
PBT 5 SPB 400		5	8	3535	101	360	91	178
PBT 6 SPB 400		6	8	3535	120	360	91	178
PBT 8 SPB 400		8	9	4040	158	360	101	267
PBT 2 SPB 450	450	2	7	3020	44	410	51	146
PBT 3 SPB 450		3	7	3535	63	410	91	178
PBT 4 SPB 450		4	7	3535	82	410	91	178
PBT 5 SPB 450		5	8	3535	101	410	91	178
PBT 6 SPB 450		6	8	4040	120	410	101	215
PBT 8 SPB 450		8	9	4040	158	410	101	215
PBT 2 SPB 500	500	2	3	3020	44	460	51	146
PBT 3 SPB 500		3	7	3535	63	460	91	178
PBT 4 SPB 500		4	7	3535	82	460	91	178
PBT 5 SPB 500		5	8	3535	101	460	91	178
PBT 6 SPB 500		6	8	4040	120	460	101	215
PBT 8 SPB 500		8	9	4040	158	460	101	215
PBT 2 SPB 560	560	2	7	3020	44	520	51	146
PBT 3 SPB 560		3	7	3535	63	520	91	178
PBT 4 SPB 560		4	7	3535	82	520	91	178
PBT 5 SPB 560		5	8	3535	101	520	91	178
PBT 6 SPB 560		6	8	4040	120	520	101	215
PBT 8 SPB 560		8	9	4040	158	520	101	215

Příklad označení - vzor objednávky: Řemenice klínová **PBT 5 SPB 450 - 3535 TL**

Řemenice pro klínové řemeny

Profil SPB - B - 5V

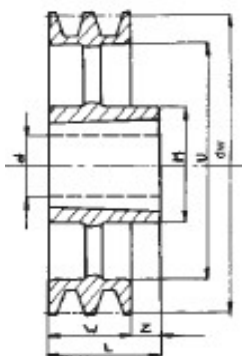

7

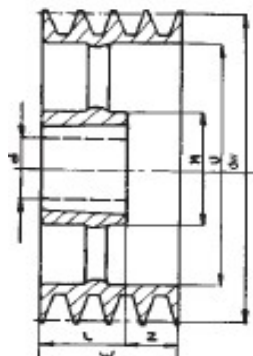

8

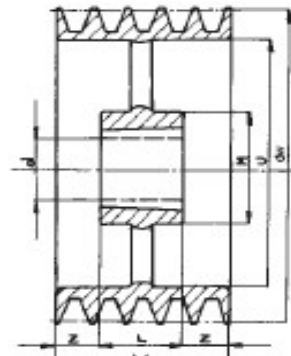

9

SPB - B - 5V

Označení řemenice	Roztečný průměr dw (mm)	Počet drážek	Typ	Pouzdro Taper Lock	Šířka věnce W (mm)	Vnitřní průměr věnce U (mm)	Šířka náboje L (mm)	Průměr náboje M (mm)
PBT 2 SPB 630	630	2	7	3535	44	590	91	178
PBT 3 SPB 630		3	7	3535	63	590	91	178
PBT 4 SPB 630		4	7	3535	82	590	91	178
PBT 5 SPB 630		5	8	4040	101	590	101	215
PBT 6 SPB 630		6	8	4040	120	590	101	215
PBT 8 SPB 630		8	9	5050	158	590	126	267
PBT 2 SPB 710	710	2	7	3535	44	670	91	178
PBT 3 SPB 710		3	7	3535	63	670	91	178
PBT 4 SPB 710		4	7	3535	82	670	91	178
PBT 5 SPB 710		5	8	4040	101	670	101	215
PBT 6 SPB 710		6	8	4040	120	670	101	215
PBT 8 SPB 710		8	9	5050	158	670	126	267
PBT 2 SPB 800	800	2	7	3535	44	760	91	178
PBT 3 SPB 800		3	7	3535	63	760	91	178
PBT 4 SPB 800		4	7	4040	82	760	101	215
PBT 5 SPB 800		5	8	4040	101	760	101	215
PBT 6 SPB 800		6	8	4040	120	760	101	215
PBT 8 SPB 800		8	9	5050	158	760	126	267
PBT 3 SPB 900	900	3	7	3535	63	860	91	178
PBT 4 SPB 900		4	7	4040	82	860	101	215
PBT 5 SPB 900		5	8	4040	101	860	101	215
PBT 6 SPB 900		6	8	4040	120	860	101	215
PBT 8 SPB 900		8	9	5050	158	860	126	267
PBT 3 SPB 1000	1000	3	7	4040	63	958	101	215
PBT 4 SPB 1000		4	7	4040	82	958	101	215
PBT 5 SPB 1000		5	8	4040	101	958	101	215
PBT 6 SPB 1000		6	8	4040	120	958	101	215
PBT 8 SPB 1000		8	9	5050	158	958	126	267
PBT 3 SPB 1250	1250	3	7	4040	63	1208	101	215
PBT 4 SPB 1250		4	7	4040	82	1208	101	215
PBT 5 SPB 1250		5	8	4040	101	1208	101	215
PBT 6 SPB 1250		6	7	5050	120	1208	126	267
PBT 8 SPB 1250		8	9	5050	158	1208	126	267

Příklad označení - vzor objednávky: Řemenice klínová **PBT 8 SPB 900 - 5050 TL**