

Ozubené řemenice

Profil H

rozteč zubů 1/2" (12.70 mm)

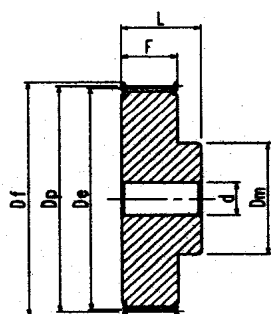

1

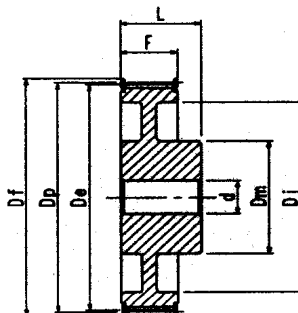

2

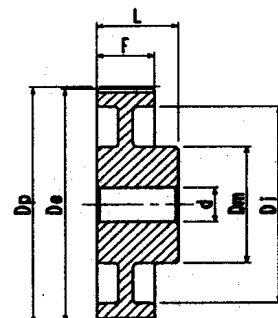

3

H 075 - pro řemen širě 3/4" (19.05 mm)

Označení řemenice	Počet zubů	Typ	Dp (mm)	De (mm)	Df (mm)	Dm (mm)	Di (mm)	F (mm)	L (mm)	d (mm)	Materiál
PD 14 H 075	14	1	56,60	55,23	62	40	-	25,4	38	-	ocel
PD 15 H 075	15	1	60,64	59,27	67	45	-	25,4	38	-	
PD 16 H 075	16	1	64,68	63,31	67	47	-	25,4	38	-	
PD 17 H 075	17	1	68,72	67,35	77	49	-	25,4	38	-	
PD 18 H 075	18	1	72,77	71,40	80	57	-	25,4	38	-	
PD 19 H 075	19	1	76,81	75,44	84	60	-	25,4	38	-	
PD 20 H 075	20	1	80,85	79,48	88	64	-	25,4	38	-	
PD 21 H 075	21	1	84,89	83,52	94	64	-	25,4	38	-	
PD 22 H 075	22	1	88,94	87,57	94	70	-	25,4	38	-	
PD 23 H 075	23	1	92,98	91,61	98	72	-	25,4	38	-	
PD 24 H 075	24	1	97,02	95,65	104	80	-	25,4	38	-	
PD 25 H 075	25	1	101,06	99,69	104	80	-	25,4	38	-	
PD 26 H 075	26	1	105,11	103,74	108	85	-	25,4	38	-	
PD 27 H 075	27	1	109,15	107,78	113	88	-	25,4	38	-	
PD 28 H 075	28	1	113,19	111,92	118	94	-	25,4	38	-	
PD 29 H 075	29	1	117,23	115,86	121	96	-	25,4	38	-	
PD 30 H 075	30	1	121,28	119,91	129	104	-	25,4	38	-	
PD 32 H 075	32	1	129,36	127,99	137	112	-	25,4	38	-	
PD 33 H 075	33	1	133,40	132,03	137	112	-	25,4	38	-	
PD 34 H 075	34	1	137,45	136,08	142	118	-	25,4	38	-	
PD 35 H 075	35	2	141,49	140,12	145	68	118	25,4	48	-	
PD 36 H 075	36	2	145,53	144,16	151	68	118	25,4	48	-	
PD 38 H 075	38	2	153,62	152,25	158	68	126	25,4	48	-	
PD 40 H 075	40	2	161,70	160,33	168	68	134	25,4	48	-	
PD 44 H 075	44	2	177,87	176,50	191	68	150	25,4	48	-	
PD 45 H 075	45	2	181,91	180,54	189	68	154	25,4	48	-	
PD 48 H 075	48	2	194,04	192,67	199	68	166	25,4	48	-	
PD 49 H 075	49	3	198,08	196,71	-	68	170	25,4	48	-	
PD 50 H 075	50	3	202,13	200,76	-	68	174	25,4	48	-	
PD 52 H 075	52	3	210,21	208,84	-	75	182	25,4	48	-	
PD 60 H 075	60	3	242,55	241,18	-	75	215	25,4	48	-	
PD 70 H 075	70	3	282,98	281,61	-	75	255	25,4	48	-	
PD 72 H 075	72	3	291,06	289,69	-	80	263	25,4	48	-	

Příklad označení - vzor objednávky: Řemenice PD 32 H 075

Ozubené řemenice

Profil H

rozteč zubů 1/2" (12.70 mm)

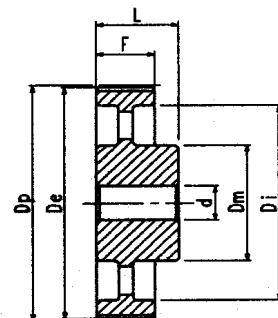

4

H 075 - pro řemen širě 3/4" (19.05 mm)

Označení řemenice	Počet zubů	Typ	Dp (mm)	De (mm)	Df (mm)	Dm (mm)	Di (mm)	F (mm)	L (mm)	d (mm)	Materiál
PD 82 H 075	82	4	331,49	330,12	-	80	304	25,4	55	-	litina
PD 84 H 075	84	4	339,57	338,20	-	90	312	25,4	55	19	
PD 94 H 075	94	4	380,00	378,63	-	90	352	25,4	55	19	
PD 96 H 075	96	4	388,08	386,71	-	100	360	25,4	55	19	
PD 106 H 075	106	4	428,51	427,14	-	100	401	25,4	55	19	
PD 116 H 075	116	4	468,93	467,56	-	100	441	25,4	55	19	
PD 118 H 075	118	4	477,02	475,65	-	100	449	25,4	55	19	
PD 120 H 075	120	4	485,10	483,73	-	100	458	25,4	55	19	
PD 150 H 075	150	4	606,38	605,01	-	100	579	25,4	55	19	
PD 152 H 075	152	4	614,46	613,09	-	100	587	25,4	55	19	
PD 154 H 075	154	4	622,55	621,17	-	100	595	25,4	55	19	
PD 156 H 075	156	4	630,63	629,26	-	120	603	25,4	55	19	

Příklad označení - vzor objednávky: Řemenice **PD 84 H 075**

Ozubené řemenice

Profil H

rozteč zubů 1/2" (12.70 mm)

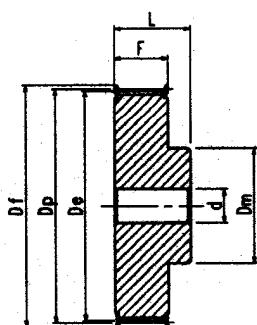
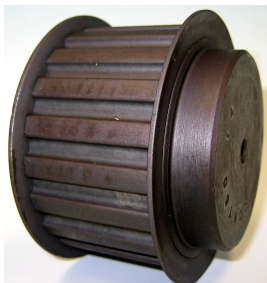

1

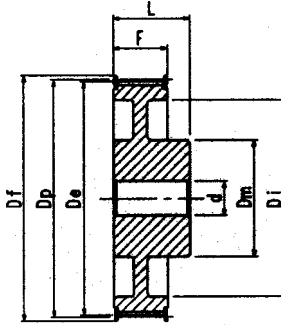

2

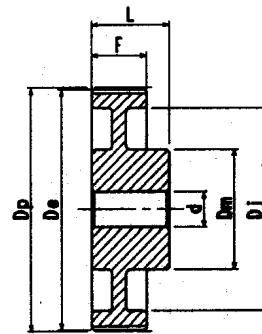

3

H 100 - pro řemen širé 1" (25.40 mm)

Označení řemenice	Počet zubů	Typ	Dp (mm)	De (mm)	Df (mm)	Dm (mm)	Di (mm)	F (mm)	L (mm)	d (mm)	Materiál
PD 14 H 100	14	1	56,60	55,23	62	40	-	33,3	44	-	ocel
PD 15 H 100	15	1	60,64	59,27	67	45	-	33,3	44	-	
PD 16 H 100	16	1	64,68	63,31	67	47	-	33,3	44	-	
PD 17 H 100	17	1	68,72	67,35	77	49	-	33,3	44	-	
PD 18 H 100	18	1	72,77	71,40	80	57	-	33,3	44	-	
PD 19 H 100	19	1	76,81	75,44	84	60	-	33,3	44	-	
PD 20 H 100	20	1	80,85	79,48	88	64	-	33,3	44	-	
PD 21 H 100	21	1	84,89	83,52	94	64	-	33,3	44	-	
PD 22 H 100	22	1	88,94	87,57	94	70	-	33,3	44	-	
PD 23 H 100	23	1	92,98	91,61	98	72	-	33,3	44	-	
PD 24 H 100	24	1	97,02	95,65	104	80	-	33,3	44	-	
PD 25 H 100	25	1	101,06	99,69	104	80	-	33,3	44	-	
PD 26 H 100	26	1	105,11	103,74	108	85	-	33,3	44	-	
PD 27 H 100	27	1	109,15	107,78	113	88	-	33,3	44	-	
PD 28 H 100	28	1	113,19	111,92	118	94	-	33,3	48	-	
PD 29 H 100	29	1	117,23	115,86	121	96	-	33,3	48	-	
PD 30 H 100	30	1	121,28	119,91	129	104	-	33,3	50	-	
PD 32 H 100	32	1	129,36	127,99	137	112	-	33,3	52	-	
PD 33 H 100	33	1	133,40	132,03	137	112	-	33,3	52	-	
PD 34 H 100	34	1	137,45	136,08	142	118	-	33,3	52	-	
PD 35 H 100	35	2	141,49	140,12	145	75	118	33,3	52	-	
PD 36 H 100	36	2	145,53	144,16	151	75	118	33,3	52	-	
PD 38 H 100	38	2	153,62	152,25	158	75	126	33,3	52	-	
PD 40 H 100	40	2	161,70	160,33	168	75	134	33,3	54	-	
PD 44 H 100	44	2	177,87	176,50	191	75	150	33,3	54	-	
PD 45 H 100	45	2	181,91	180,54	189	75	154	33,3	54	-	
PD 48 H 100	48	2	194,04	192,67	199	75	166	33,3	60	-	
PD 49 H 100	49	3	198,08	196,71	-	75	170	33,3	60	-	
PD 50 H 100	50	3	202,13	200,76	-	75	174	33,3	60	-	
PD 52 H 100	52	3	210,21	208,84	-	75	182	33,3	60	-	
PD 60 H 100	60	3	242,55	241,18	-	80	215	33,3	60	-	
PD 70 H 100	70	3	282,98	281,61	-	80	255	33,3	60	-	
PD 72 H 100	72	3	291,06	289,69	-	80	263	33,3	60	-	

Příklad označení - vzor objednávky: Řemenice PD 32 H 100

Ozubené řemenice

Profil H

rozteč zubů 1/2" (12.70 mm)

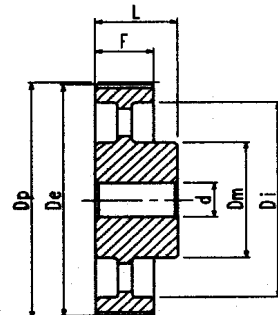

4

H 100 - pro řemen širě 1" (25.40 mm)

Označení řemenice	Počet zubů	Typ	Dp (mm)	De (mm)	Df (mm)	Dm (mm)	Di (mm)	F (mm)	L (mm)	d (mm)	Materiál
PD 82 H 100	82	4	331,49	330,12	-	80	304	33,3	60	-	litina
PD 84 H 100	84	4	339,57	338,20	-	90	312	33,3	60	19	
PD 94 H 100	94	4	380,00	378,63	-	90	352	33,3	60	19	
PD 96 H 100	96	4	388,08	386,71	-	100	360	33,3	60	19	
PD 106 H 100	106	4	428,51	427,14	-	100	401	33,3	60	19	
PD 116 H 100	116	4	468,93	467,56	-	100	441	33,3	60	19	
PD 118 H 100	118	4	477,02	475,65	-	100	449	33,3	60	19	
PD 120 H 100	120	4	485,10	483,73	-	100	458	33,3	60	19	
PD 150 H 100	150	4	606,38	605,01	-	100	579	33,3	60	19	
PD 152 H 100	152	4	614,46	613,09	-	100	587	33,3	60	19	
PD 154 H 100	154	4	622,55	621,17	-	100	595	33,3	60	19	
PD 156 H 100	156	4	630,63	629,26	-	120	603	33,3	60	19	

 Příklad označení - vzor objednávky: Řemenice **PD 84 H 100**

Ozubené řemenice

Profil H

rozteč zubů 1/2" (12.70 mm)

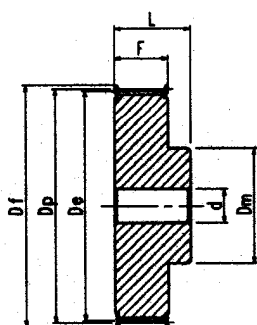
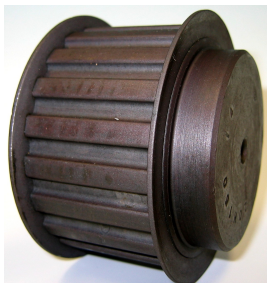

1

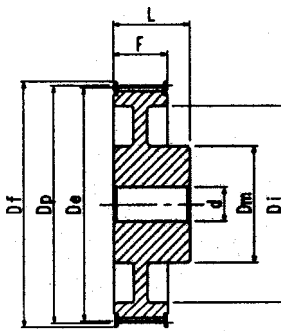

2

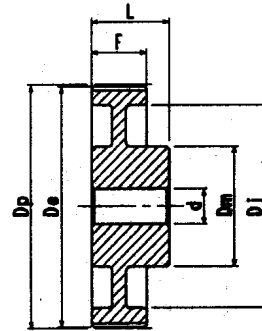

3

H 150 - pro řemen širě 1"1/2 (38.10 mm)

Označení řemenice	Počet zubů	Typ	Dp (mm)	De (mm)	Df (mm)	Dm (mm)	Di (mm)	F (mm)	L (mm)	d (mm)	Materiál
PD 14 H 150	14	1	56,60	55,23	62	40	-	46	58	-	ocel
PD 15 H 150	15	1	60,64	59,27	67	45	-	46	58	-	
PD 16 H 150	16	1	64,68	63,31	67	47	-	46	58	-	
PD 17 H 150	17	1	68,72	67,35	77	49	-	46	58	-	
PD 18 H 150	18	1	72,77	71,40	80	57	-	46	58	-	
PD 19 H 150	19	1	76,81	75,44	84	60	-	46	58	-	
PD 20 H 150	20	1	80,85	79,48	88	64	-	46	58	-	
PD 21 H 150	21	1	84,89	83,52	94	64	-	46	58	-	
PD 22 H 150	22	1	88,94	87,57	94	70	-	46	58	-	
PD 23 H 150	23	1	92,98	91,61	98	72	-	46	58	-	
PD 24 H 150	24	1	97,02	95,65	104	80	-	46	58	-	
PD 25 H 150	25	1	101,06	99,69	104	80	-	46	58	-	
PD 26 H 150	26	1	105,11	103,74	108	85	-	46	58	-	litina
PD 27 H 150	27	1	109,15	107,78	113	88	-	46	58	-	
PD 28 H 150	28	1	113,19	111,92	118	94	-	46	58	-	
PD 29 H 150	29	1	117,23	115,86	121	96	-	46	58	-	
PD 30 H 150	30	1	121,28	119,91	129	104	-	46	58	-	
PD 32 H 150	32	1	129,36	127,99	137	112	-	46	58	-	
PD 33 H 150	33	1	133,40	132,03	137	112	-	46	58	-	
PD 34 H 150	34	1	137,45	136,08	142	118	-	46	58	-	
PD 35 H 150	35	2	141,49	140,12	145	75	118	46	58	-	
PD 36 H 150	36	2	145,53	144,16	151	75	118	46	58	-	
PD 38 H 150	38	2	153,62	152,25	158	75	126	46	58	-	
PD 40 H 150	40	2	161,70	160,33	168	75	134	46	70	-	
PD 44 H 150	44	2	177,87	176,50	191	75	150	46	70	-	
PD 45 H 150	45	2	181,91	180,54	189	75	154	46	70	-	
PD 48 H 150	48	2	194,04	192,67	199	75	166	46	70	-	
PD 49 H 150	49	3	198,08	196,71	-	75	170	46	70	-	
PD 50 H 150	50	3	202,13	200,76	-	75	174	46	70	-	
PD 52 H 150	52	3	210,21	208,84	-	75	182	46	70	-	
PD 60 H 150	60	3	242,55	241,18	-	80	215	46	70	-	
PD 70 H 150	70	3	282,98	281,61	-	80	255	46	70	-	
PD 72 H 150	72	3	291,06	289,69	-	80	263	46	70	-	

Příklad označení - vzor objednávky: Řemenice PD 32 H 150

Ozubené řemenice

Profil H

rozteč zubů 1/2" (12.70 mm)

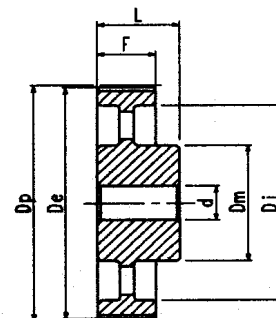

4

H 150 - pro řemen širě 1"1/2 (38.10 mm)

Označení řemenice	Počet zubů	Typ	Dp (mm)	De (mm)	Df (mm)	Dm (mm)	Di (mm)	F (mm)	L (mm)	d (mm)	Materiál
PD 82 H 150	82	4	331,49	330,12	-	80	304	46	70	-	litina
PD 84 H 150	84	4	339,57	338,20	-	90	312	46	70	19	
PD 94 H 150	94	4	380,00	378,63	-	90	352	46	70	19	
PD 96 H 150	96	4	388,08	386,71	-	100	360	46	70	19	
PD 106 H 150	106	4	428,51	427,14	-	100	401	46	70	19	
PD 116 H 150	116	4	468,93	467,56	-	100	441	46	70	19	
PD 118 H 150	118	4	477,02	475,65	-	100	449	46	70	19	
PD 120 H 150	120	4	485,10	483,73	-	100	458	46	70	19	
PD 150 H 150	150	4	606,38	605,01	-	100	579	46	70	19	
PD 152 H 150	152	4	614,46	613,09	-	100	587	46	70	19	
PD 154 H 150	154	4	622,55	621,17	-	100	595	46	70	19	
PD 156 H 150	156	4	630,63	629,26	-	120	603	46	70	19	

 Příklad označení - vzor objednávky: Řemenice **PD 84 H 150**

Ozubené řemenice

Profil H

rozteč zubů 1/2" (12.70 mm)

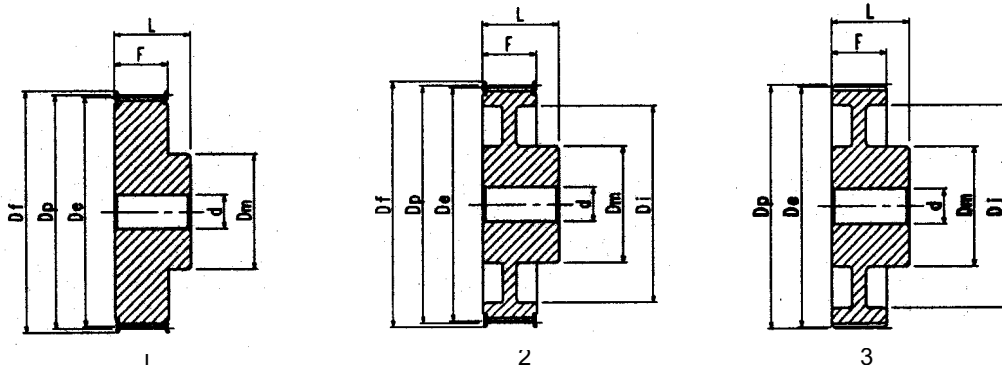
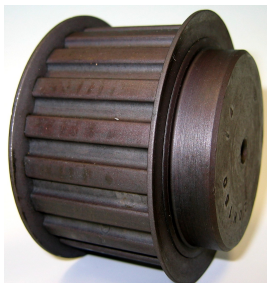
H 200 - pro řemen širé 2" (50.80 mm)

Označení řemenice	Počet zubů	Typ	Dp (mm)	De (mm)	Df (mm)	Dm (mm)	Di (mm)	F (mm)	L (mm)	d (mm)	Materiál
PD 14 H 200	14	1	56,60	55,23	62	40	-	59,5	72	-	ocel
PD 15 H 200	15	1	60,64	59,27	67	45	-	59,5	72	-	
PD 16 H 200	16	1	64,68	63,31	67	47	-	59,5	72	-	
PD 17 H 200	17	1	68,72	67,35	77	49	-	59,5	72	-	
PD 18 H 200	18	1	72,77	71,40	80	57	-	59,5	72	-	
PD 19 H 200	19	1	76,81	75,44	84	60	-	59,5	72	-	
PD 20 H 200	20	1	80,85	79,48	88	64	-	59,5	72	-	
PD 21 H 200	21	1	84,89	83,52	94	64	-	59,5	72	-	
PD 22 H 200	22	1	88,94	87,57	94	70	-	59,5	72	-	
PD 23 H 200	23	1	92,98	91,61	98	72	-	59,5	72	-	
PD 24 H 200	24	1	97,02	95,65	104	80	-	59,5	72	-	
PD 25 H 200	25	1	101,06	99,69	104	80	-	59,5	72	-	
PD 26 H 200	26	1	105,11	103,74	108	85	-	59,5	72	-	
PD 27 H 200	27	1	109,15	107,78	113	88	-	59,5	72	-	
PD 28 H 200	28	1	113,19	111,92	118	94	-	59,5	72	-	
PD 29 H 200	29	1	117,23	115,86	121	96	-	59,5	72	-	
PD 30 H 200	30	1	121,28	119,91	129	104	-	59,5	72	-	
PD 32 H 200	32	1	129,36	127,99	137	112	-	59,5	72	-	
PD 33 H 200	33	1	133,40	132,03	137	112	-	59,5	72	-	
PD 34 H 200	34	1	137,45	136,08	142	118	-	59,5	72	-	
PD 35 H 200	35	2	141,49	140,12	145	80	118	59,5	72	-	
PD 36 H 200	36	2	145,53	144,16	151	80	118	59,5	72	-	
PD 38 H 200	38	2	153,62	152,25	158	80	126	59,5	72	-	
PD 40 H 200	40	2	161,70	160,33	168	80	134	59,5	72	-	
PD 44 H 200	44	2	177,87	176,50	191	80	150	59,5	72	-	
PD 45 H 200	45	2	181,91	180,54	189	80	154	59,5	72	-	
PD 48 H 200	48	2	194,04	192,67	199	80	166	59,5	80	-	
PD 49 H 200	49	3	198,08	196,71	-	80	170	59,5	80	-	
PD 50 H 200	50	3	202,13	200,76	-	80	174	59,5	80	-	
PD 52 H 200	52	3	210,21	208,84	-	80	182	59,5	80	-	
PD 60 H 200	60	3	242,55	241,18	-	90	215	59,5	80	-	
PD 70 H 200	70	3	282,98	281,61	-	90	255	59,5	80	-	
PD 72 H 200	72	3	291,06	289,69	-	90	263	59,5	80	-	

Příklad označení - vzor objednávky: Řemenice PD 32 H 200

Ozubené řemenice

Profil H

rozteč zubů 1/2" (12.70 mm)

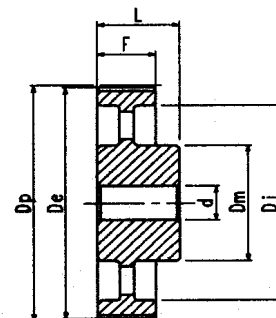
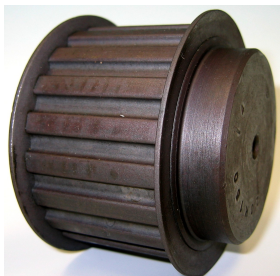

4

H 200 - pro řemen širě 2" (50.80 mm)

Označení řemenice	Počet zubů	Typ	Dp (mm)	De (mm)	Df (mm)	Dm (mm)	Di (mm)	F (mm)	L (mm)	d (mm)	Materiál
PD 82 H 200	82	4	331,49	330,12	-	90	304	59,5	80	-	litina
PD 84 H 200	84	4	339,57	338,20	-	100	312	59,5	80	19	
PD 94 H 200	94	4	380,00	378,63	-	100	352	59,5	80	19	
PD 96 H 200	96	4	388,08	386,71	-	100	360	59,5	80	19	
PD 106 H 200	106	4	428,51	427,14	-	100	401	59,5	80	19	
PD 116 H 200	116	4	468,93	467,56	-	100	441	59,5	80	19	
PD 118 H 200	118	4	477,02	475,65	-	100	449	59,5	80	19	
PD 120 H 200	120	4	485,10	483,73	-	120	458	59,5	80	19	
PD 150 H 200	150	4	606,38	605,01	-	120	579	59,5	80	19	
PD 152 H 200	152	4	614,46	613,09	-	120	587	59,5	80	19	
PD 154 H 200	154	4	622,55	621,17	-	120	595	59,5	80	19	
PD 156 H 200	156	4	630,63	629,26	-	120	603	59,5	80	19	

 Příklad označení - vzor objednávky: Řemenice **PD 84 H 200**

Ozubené řemenice

Profil H

rozteč zubů 1/2" (12.70 mm)

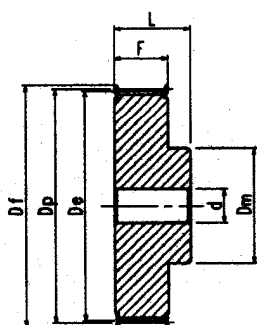
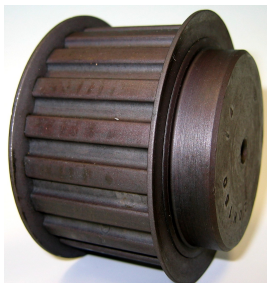

1

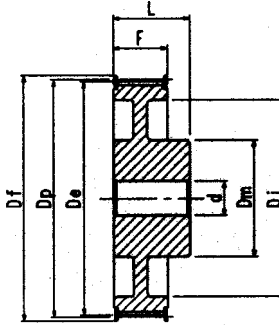

2

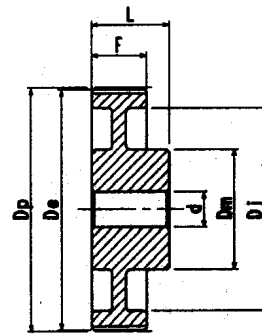

3

H 300 - pro řemen širě 3" (76.20 mm)

Označení řemenice	Počet zubů	Typ	Dp (mm)	De (mm)	Df (mm)	Dm (mm)	Di (mm)	F (mm)	L (mm)	d (mm)	Materiál
PD 14 H 300	14	1	56,60	55,23	62	40	-	85,7	98	-	ocel
PD 15 H 300	15	1	60,64	59,27	67	45	-	85,7	98	-	
PD 16 H 300	16	1	64,68	63,31	67	47	-	85,7	98	-	
PD 17 H 300	17	1	68,72	67,35	77	49	-	85,7	98	-	
PD 18 H 300	18	1	72,77	71,40	80	57	-	85,7	98	-	
PD 19 H 300	19	1	76,81	75,44	84	60	-	85,7	98	-	
PD 20 H 300	20	1	80,85	79,48	88	64	-	85,7	98	-	
PD 21 H 300	21	1	84,89	83,52	94	64	-	85,7	98	-	
PD 22 H 300	22	1	88,94	87,57	94	70	-	85,7	98	-	
PD 23 H 300	23	1	92,98	91,61	98	72	-	85,7	98	-	
PD 24 H 300	24	1	97,02	95,65	104	80	-	85,7	98	-	
PD 25 H 300	25	1	101,06	99,69	104	80	-	85,7	98	-	
PD 26 H 300	26	1	105,11	103,74	108	85	-	85,7	98	-	
PD 27 H 300	27	1	109,15	107,78	113	88	-	85,7	98	-	
PD 28 H 300	28	1	113,19	111,92	118	94	-	85,7	98	-	
PD 29 H 300	29	1	117,23	115,86	121	96	-	85,7	98	-	
PD 30 H 300	30	1	121,28	119,91	129	104	-	85,7	98	-	
PD 32 H 300	32	1	129,36	127,99	137	112	-	85,7	98	-	
PD 33 H 300	33	1	133,40	132,03	137	112	-	85,7	98	-	
PD 34 H 300	34	1	137,45	136,08	142	118	-	85,7	98	-	
PD 35 H 300	35	2	141,49	140,12	145	75	118	85,7	98	-	
PD 36 H 300	36	2	145,53	144,16	151	80	118	85,7	98	-	
PD 38 H 300	38	2	153,62	152,25	158	80	126	85,7	98	-	
PD 40 H 300	40	2	161,70	160,33	168	80	134	85,7	98	-	
PD 44 H 300	44	2	177,87	176,50	191	80	150	85,7	98	-	
PD 45 H 300	45	2	181,91	180,54	189	80	154	85,7	98	-	
PD 48 H 300	48	2	194,04	192,67	199	90	166	85,7	98	-	
PD 49 H 300	49	3	198,08	196,71	-	90	170	85,7	98	-	
PD 50 H 300	50	3	202,13	200,76	-	90	174	85,7	98	-	
PD 52 H 300	52	3	210,21	208,84	-	90	182	85,7	98	-	
PD 60 H 300	60	3	242,55	241,18	-	100	215	85,7	98	-	
PD 70 H 300	70	3	282,98	281,61	-	100	255	85,7	98	-	
PD 72 H 300	72	3	291,06	289,69	-	100	263	85,7	98	-	

Příklad označení - vzor objednávky: Řemenice PD 32 H 300

Ozubené řemenice

Profil H

rozteč zubů 1/2" (12.70 mm)

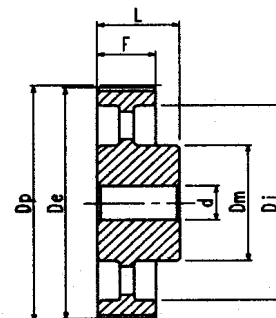

4

H 300 - pro řemen širě 3" (76.20 mm)

Označení řemenice	Počet zubů	Typ	Dp (mm)	De (mm)	Df (mm)	Dm (mm)	Di (mm)	F (mm)	L (mm)	d (mm)	Materiál
PD 82 H 300	82	4	331,49	330,12	-	100	304	85,7	98	-	litina
PD 84 H 300	84	4	339,57	338,20	-	100	312	85,7	98	19	
PD 94 H 300	94	4	380,00	378,63	-	100	352	85,7	98	19	
PD 96 H 300	96	4	388,08	386,71	-	110	360	85,7	98	19	
PD 106 H 300	106	4	428,51	427,14	-	110	401	85,7	98	19	
PD 116 H 300	116	4	468,93	467,56	-	110	441	85,7	98	19	
PD 118 H 300	118	4	477,02	475,65	-	110	449	85,7	98	19	
PD 120 H 300	120	4	485,10	483,73	-	120	458	85,7	98	19	
PD 150 H 300	150	4	606,38	605,01	-	120	579	85,7	98	19	
PD 152 H 300	152	4	614,46	613,09	-	120	587	85,7	98	19	
PD 154 H 300	154	4	622,55	621,17	-	120	595	85,7	98	19	
PD 156 H 300	156	4	630,63	629,26	-	130	603	85,7	98	19	

Příklad označení - vzor objednávky: Řemenice **PD 84 H 300**

Ozubené řemenice - systém TAPER LOCK

Profil H

rozteč zubů 1/2" (12.70 mm)

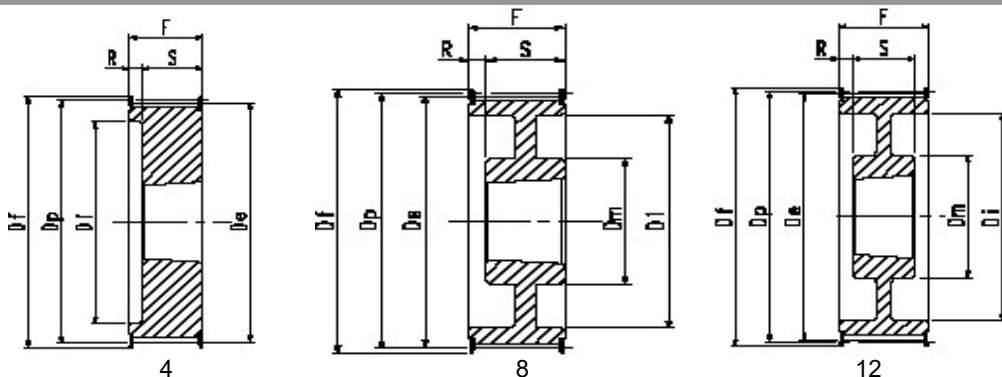
H 100 - pro řemen širě 1" (25.40 mm)

Označení řemenice	Počet zubů	Typ	Typ pouzdra	Dp (mm)	De (mm)	Di (mm)	Df (mm)	F (mm)	Dm (mm)	S (mm)	R (mm)	Materiál
PBD 14 H 100	14	4	1108	56,60	55,23	37	62	31	-	22	9	litina
PBD 15 H 100	15	4	1108	60,64	59,27	37	67	31	-	22	9	
PBD 16 H 100	16	4	1108	64,68	63,31	46	67	31	-	22	9	
PBD 17 H 100	17	4	1210	68,72	67,35	46	77	31	-	25	6	
PBD 18 H 100	18	4	1210	72,77	71,40	56	80	31	-	25	6	
PBD 19 H 100	19	4	1210	76,81	75,44	56	84	31	-	25	6	
PBD 20 H 100	20	4	1210	80,85	79,48	56	88	31	-	25	6	
PBD 21 H 100	21	4	1210	84,89	83,52	62	94	32	-	25	7	
PBD 22 H 100	22	4	1210	88,94	87,57	62	94	32	-	25	7	
PBD 23 H 100	23	4	1610	92,98	91,61	71	98	32	-	25	7	
PBD 24 H 100	24	4	1610	97,02	95,65	71	104	32	-	25	7	
PBD 25 H 100	25	4	1610	101,06	99,69	78	104	32	-	25	7	
PBD 26 H 100	26	4	1610	105,11	103,74	78	108	32	-	25	7	
PBD 27 H 100	27	4	1610	109,15	107,78	86	113	32	-	25	7	
PBD 28 H 100	28	4	1610	113,19	111,92	86	118	32	-	25	7	
PBD 29 H 100	29	4	1610	117,23	115,86	95	121	32	-	25	7	
PBD 30 H 100	30	4	1610	121,28	119,91	95	129	32	-	25	7	
PBD 32 H 100	32	8	1610	129,36	127,99	110	137	32	82	25	7	
PBD 33 H 100	33	8	1610	133,40	132,03	112	137	32	82	25	7	
PBD 34 H 100	34	8	1610	137,45	136,08	112	142	32	82	25	7	
PBD 35 H 100	35	8	1610	141,49	140,12	120	145	32	82	25	7	
PBD 36 H 100	36	8	1610	145,53	144,16	120	151	32	82	25	7	
PBD 38 H 100	38	8	1610	153,62	152,25	136	158	32	82	25	7	
PBD 40 H 100	40	8	1610	161,70	160,33	136	168	32	82	25	7	
PBD 44 H 100	44	7	2012	177,87	176,50	162	191	32	110	32	-	
PBD 45 H 100	45	7	2012	181,91	180,54	162	189	32	110	32	-	
PBD 48 H 100	48	7	2012	194,04	192,67	168	199	32	110	32	-	
PBD 49 H 100	49	12	2012	198,08	196,71	172	-	34	110	32	1	
PBD 50 H 100	20	12	2012	202,13	200,76	172	-	34	110	32	1	
PBD 52 H 100	52	12	2012	210,21	208,84	185	-	34	110	32	1	
PBD 60 H 100	60	12	2012	242,55	241,18	217	-	34	110	32	1	
PBD 70 H 100	70	15	2012	282,98	281,61	264	-	34	110	32	1	
PBD 72 H 100	72	15	2012	291,06	289,69	264	-	34	110	32	1	

 Příklad označení - vzor objednávky: Řemenice **PBD 50 H 100**

Ozubené řemenice - systém TAPER LOCK

Profil H

rozteč zubů 1/2" (12.70 mm)

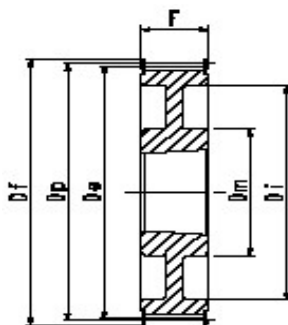

7

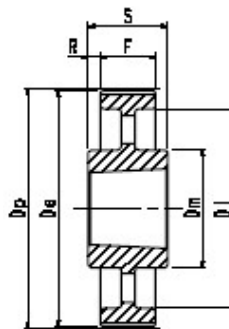

13

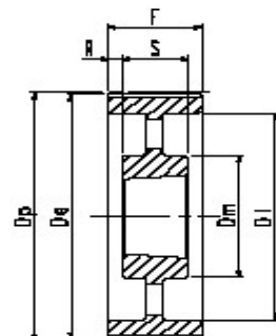

15

H 100 - pro řemen širě 1" (25.40 mm)

Označení řemenice	Počet zubů	Typ	Typ pouzdra	Dp (mm)	De (mm)	Di (mm)	Df (mm)	F (mm)	Dm (mm)	S (mm)	R (mm)	Materiál
PBD 82 H 100	82	15	2012	331,49	330,12	312	-	34	110	32	1	litina
PBD 84 H 100	84	15	2012	339,57	338,20	312	-	34	110	32	1	
PBD 94 H 100	94	13	2517	380,00	378,63	357	-	34	120	45	5,5	
PBD 96 H 100	96	13	2517	388,08	386,71	357	-	34	120	45	5,5	
PBD 106 H 100	106	13	2517	428,51	427,14	402	-	34	120	45	5,5	
PBD 116 H 100	116	13	2517	468,93	467,56	442	-	34	120	45	5,5	
PBD 118 H 100	118	13	2517	477,02	475,65	457	-	34	120	45	5,5	
PBD 120 H 100	120	13	2517	485,10	483,73	457	-	34	120	45	5,5	

Příklad označení - vzor objednávky: Řemenice **PBD 106 H 100**

Ozubené řemenice - systém TAPER LOCK

Profil H

rozteč zubů 1/2" (12.70 mm)

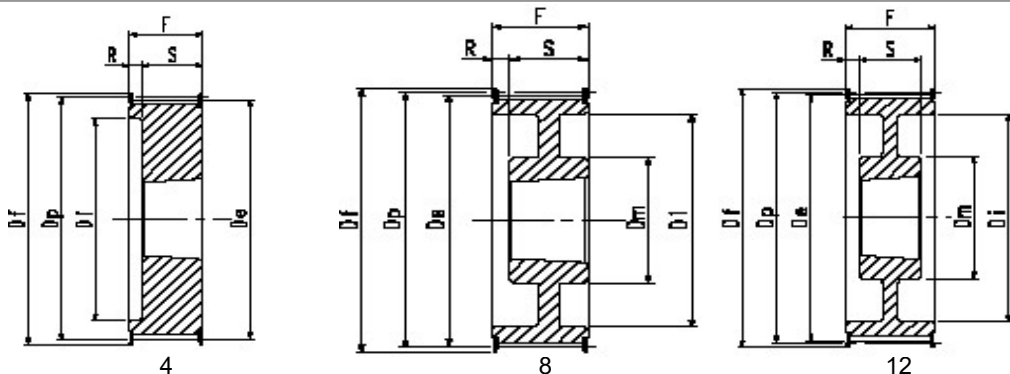
H 150 - pro řemen širě 1 1/2" (38.10 mm)

Označení řemenice	Počet zubů	Typ	Typ pouzdra	Dp (mm)	De (mm)	Di (mm)	Df (mm)	F (mm)	Dm (mm)	S (mm)	R (mm)	Materiál
PBD 14 H 150	14	4	1108	56,60	55,23	37	62	45	-	22	23	litina
PBD 15 H 150	15	4	1108	60,64	59,27	37	67	45	-	22	23	
PBD 16 H 150	16	4	1108	64,68	63,31	46	67	45	-	22	23	
PBD 17 H 150	17	4	1210	68,72	67,35	46	77	45	-	25	20	
PBD 18 H 150	18	4	1210	72,77	71,40	56	80	45	-	25	20	
PBD 19 H 150	19	4	1210	76,81	75,44	56	84	45	-	25	20	
PBD 20 H 150	20	4	1210	80,85	79,48	56	88	45	-	25	20	
PBD 21 H 150	21	4	1210	84,89	83,52	62	94	45	-	25	20	
PBD 22 H 150	22	4	1210	88,94	87,57	62	94	45	-	25	20	
PBD 23 H 150	23	4	1610	92,98	91,61	71	98	45	-	25	20	
PBD 24 H 150	24	4	1610	97,02	95,65	71	104	45	-	25	20	
PBD 25 H 150	25	4	1610	101,06	99,69	78	104	45	-	25	20	
PBD 26 H 150	26	4	1610	105,11	103,74	78	108	45	-	25	20	
PBD 27 H 150	27	4	1610	109,15	107,78	86	113	45	-	25	20	
PBD 28 H 150	28	4	1610	113,19	111,92	86	118	45	-	25	20	
PBD 29 H 150	29	4	1610	117,23	115,86	95	121	45	-	25	20	
PBD 30 H 150	30	4	1610	121,28	119,91	95	129	45	-	25	20	
PBD 32 H 150	32	8	1610	129,36	127,99	110	137	45	82	25	20	
PBD 33 H 150	33	8	1610	133,40	132,03	112	137	45	82	25	20	
PBD 34 H 150	34	8	1610	137,45	136,08	112	142	45	82	25	20	
PBD 35 H 150	35	8	1610	141,49	140,12	120	145	45	82	25	20	
PBD 36 H 150	36	8	1610	145,53	144,16	120	151	45	82	25	20	
PBD 38 H 150	38	8	1610	153,62	152,25	136	158	45	82	25	20	
PBD 40 H 150	40	8	1610	161,70	160,33	136	168	45	82	25	20	
PBD 44 H 150	44	8	2012	177,87	176,50	162	191	45	110	32	13	
PBD 45 H 150	45	8	2012	181,91	180,54	162	189	45	110	32	13	
PBD 48 H 150	48	8	2012	194,04	192,67	168	199	45	110	32	13	
PBD 49 H 150	49	12	2012	198,08	196,71	172	-	46	110	32	7	
PBD 50 H 150	50	12	2012	202,13	200,76	172	-	46	110	32	7	
PBD 52 H 150	52	12	2012	210,21	208,84	185	-	46	110	32	7	
PBD 60 H 150	60	15	2012	242,55	241,18	217	-	46	110	32	7	
PBD 70 H 150	70	15	2012	282,98	281,61	264	-	46	110	32	7	
PBD 72 H 150	72	15	2012	291,06	289,69	264	-	46	110	32	7	

 Příklad označení - vzor objednávky: Řemenice **PBD 50 H 150**

Ozubené řemenice - systém TAPER LOCK

Profil H

rozteč zubů 1/2" (12.70 mm)

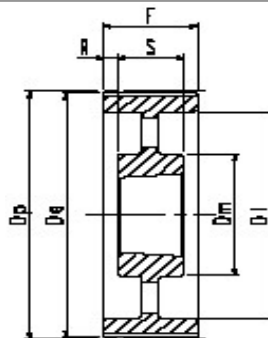

15

H 150 - pro řemen širě 1"1/2 (38.10 mm)

Označení řemenice	Počet zubů	Typ	Typ pouzdra	Dp (mm)	De (mm)	Di (mm)	Df (mm)	F (mm)	Dm (mm)	S (mm)	R (mm)	Materiál
PBD 82 H 150	82	15	2012	331,49	330,12	312	-	46	110	32	7	litina
PBD 84 H 150	84	15	2012	339,57	338,20	312	-	46	110	32	7	
PBD 94 H 150	94	15	2517	380,00	378,63	357	-	46	120	45	0,5	
PBD 96 H 150	96	15	2517	388,08	386,71	357	-	46	120	45	0,5	
PBD 106 H 150	106	15	2517	428,51	427,14	402	-	46	120	45	0,5	
PBD 116 H 150	116	15	2517	468,93	467,56	442	-	46	120	45	0,5	
PBD 118 H 150	118	15	2517	477,02	475,65	457	-	46	120	45	0,5	
PBD 120 H 150	120	15	2517	485,10	483,73	457	-	46	120	45	0,5	

Příklad označení - vzor objednávky: Řemenice **PBD 106 H 150**

Ozubené řemenice - systém TAPER LOCK

Profil H

rozteč zubů 1/2" (12.70 mm)

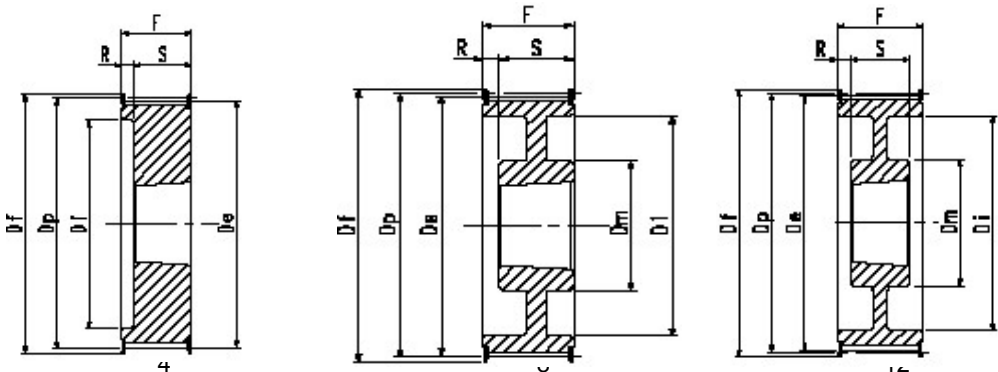

H 200 - pro řemen širě 2" (50.80 mm)

Označení řemenice	Počet zubů	Typ	Typ pouzdra	Dp (mm)	De (mm)	Di (mm)	Df (mm)	F (mm)	Dm (mm)	S (mm)	R (mm)	Materiál
PBD 16 H 200	16	4	1108	64,68	63,31	46	67	58	-	22	36	litina
PBD 17 H 200	17	4	1210	68,72	67,35	46	77	58	-	25	33	
PBD 18 H 200	18	4	1210	72,77	71,40	56	80	58	-	25	33	
PBD 19 H 200	19	4	1610	76,81	75,44	56	84	58	-	25	33	
PBD 20 H 200	20	4	1610	80,85	79,48	56	88	58	-	25	33	
PBD 21 H 200	21	4	1610	84,89	83,52	62	94	58	-	25	33	
PBD 22 H 200	22	4	1610	88,94	87,57	62	94	58	-	25	33	
PBD 23 H 200	23	4	1610	92,98	91,61	71	98	58	-	25	33	
PBD 24 H 200	24	4	1610	97,02	95,65	71	104	58	-	25	33	
PBD 25 H 200	25	4	1610	101,06	99,69	78	104	58	-	25	33	
PBD 26 H 200	26	4	1610	105,11	103,74	78	108	58	-	25	33	
PBD 27 H 200	27	4	1610	109,15	107,78	86	113	58	-	25	33	
PBD 28 H 200	28	4	1610	113,19	111,92	86	118	58	-	25	33	
PBD 29 H 200	29	4	1610	117,23	115,86	95	121	58	-	25	33	
PBD 30 H 200	30	4	1610	121,28	119,91	95	129	58	-	25	33	
PBD 32 H 200	32	4	2012	129,36	127,99	110	137	58	-	32	26	
PBD 33 H 200	33	4	2012	133,40	132,03	112	137	58	-	32	26	
PBD 34 H 200	34	4	2012	137,45	136,08	112	142	58	-	32	26	
PBD 35 H 200	35	8	2012	141,49	140,12	120	145	58	102	32	26	
PBD 36 H 200	36	8	2012	145,53	144,16	120	151	58	102	32	26	
PBD 38 H 200	38	8	2012	153,62	152,25	136	158	58	110	32	26	
PBD 40 H 200	40	8	2012	161,70	160,33	136	168	58	110	32	26	
PBD 44 H 200	44	8	2012	177,87	176,50	162	191	58	110	32	26	
PBD 45 H 200	45	8	2012	181,91	180,54	162	189	58	110	32	26	
PBD 48 H 200	48	8	2517	194,04	192,67	168	199	58	120	45	13	
PBD 49 H 200	49	12	2517	198,08	196,71	172	-	60	120	45	7,5	
PBD 50 H 200	20	12	2517	202,13	200,76	172	-	60	120	45	7,5	
PBD 52 H 200	52	12	2517	210,21	208,84	185	-	60	120	45	7,5	
PBD 60 H 200	60	15	2517	242,55	241,18	217	-	60	120	45	7,5	
PBD 70 H 200	70	15	2517	282,98	281,61	264	-	60	120	45	7,5	
PBD 72 H 200	72	15	2517	291,06	289,69	264	-	60	120	45	7,5	
PBD 82 H 200	82	15	2517	331,49	330,12	312	-	60	120	45	7,5	
PBD 84 H 200	84	15	2517	339,57	338,20	312	-	60	120	45	7,5	

Příklad označení - vzor objednávky: Řemenice **PBD 50 H 200**

Ozubené řemenice - systém TAPER LOCK

Profil H

rozteč zubů 1/2" (12.70 mm)

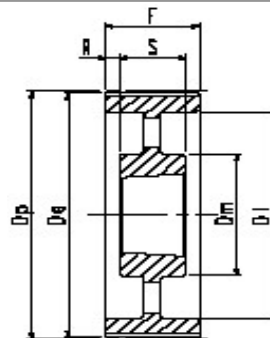

15

H 200 - pro řemen širě 2" (50.80 mm)

Označení řemenice	Počet zubů	Typ	Typ pouzdra	Dp (mm)	De (mm)	Di (mm)	Df (mm)	F (mm)	Dm (mm)	S (mm)	R (mm)	Materiál
PBD 94 H 200	94	15	2517	380,00	378,63	357	-	60	120	45	7,5	litina
PBD 96 H 200	96	15	2517	388,08	386,71	357	-	60	120	45	7,5	
PBD 106 H 200	106	15	2517	428,51	427,14	402	-	60	120	45	7,5	
PBD 116 H 200	116	15	2517	468,93	467,56	442	-	60	120	45	7,5	
PBD 118 H 200	118	15	2517	477,02	475,65	457	-	60	120	45	7,5	
PBD 120 H 200	120	15	2517	485,10	483,73	457	-	60	120	45	7,5	

Příklad označení - vzor objednávky: Řemenice **PBD 106 H 200**

Ozubené řemenice - systém TAPER LOCK

Profil H

rozteč zubů 1/2" (12.70 mm)

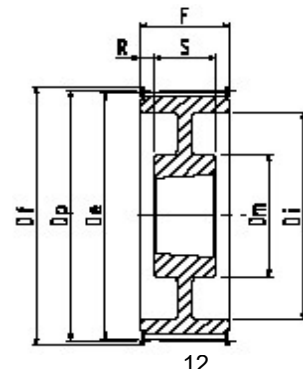
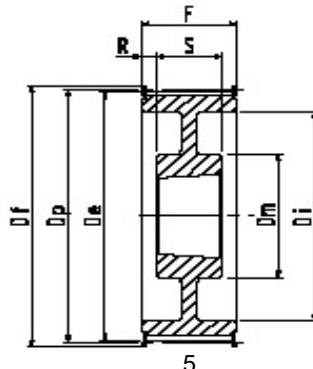
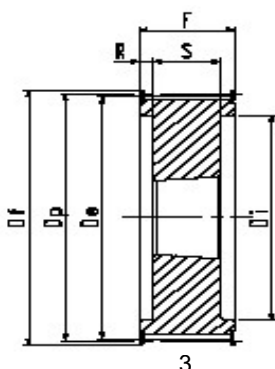
H 300 - pro řemen širě 3" (76.20 mm)

Označení řemenice	Počet zubů	Typ	Typ pouzdra	Dp (mm)	De (mm)	Di (mm)	Df (mm)	F (mm)	Dm (mm)	S (mm)	R (mm)	Materiál
PBD 19 H 300	19	3	1215	76,81	75,44	56	84	84	-	38	23	litina
PBD 20 H 300	20	3	1615	80,85	79,48	56	88	84	-	38	23	
PBD 21 H 300	21	3	1615	84,89	83,52	62	94	84	-	38	23	
PBD 22 H 300	22	3	1615	88,94	87,57	62	94	84	-	38	23	
PBD 23 H 300	23	3	1615	92,98	91,61	71	98	84	-	38	23	
PBD 24 H 300	24	3	1615	97,02	95,65	71	104	84	-	38	23	
PBD 25 H 300	25	3	1615	101,06	99,69	78	104	84	-	38	23	
PBD 26 H 300	26	3	1615	105,11	103,74	78	108	84	-	38	23	
PBD 27 H 300	27	3	2012	109,15	107,78	86	113	84	-	32	26	
PBD 28 H 300	28	3	2012	113,19	111,92	86	118	84	-	32	26	
PBD 29 H 300	29	3	2012	117,23	115,86	95	121	84	-	32	26	
PBD 30 H 300	30	3	2012	121,28	119,91	95	129	84	-	32	26	
PBD 32 H 300	32	3	2517	129,36	127,99	110	137	84	-	45	19,5	
PBD 33 H 300	33	3	2517	133,40	132,03	112	137	84	-	45	19,5	
PBD 34 H 300	34	3	2517	137,45	136,08	112	142	84	-	45	19,5	
PBD 35 H 300	35	3	2517	141,49	140,12	120	145	84	-	45	19,5	
PBD 36 H 300	36	3	2517	145,53	144,16	120	151	84	-	45	19,5	
PBD 38 H 300	38	5	2517	153,62	152,25	136	158	84	120	45	19,5	
PBD 40 H 300	40	5	2517	161,70	160,33	136	168	84	120	45	19,5	
PBD 44 H 300	44	5	2517	177,87	176,50	162	191	86	120	45	20,5	
PBD 45 H 300	45	5	2517	181,91	180,54	162	189	86	120	45	20,5	
PBD 48 H 300	48	5	2517	194,04	192,67	168	199	86	120	45	20,5	
PBD 49 H 300	49	12	2517	198,08	196,71	172	-	86	120	45	20,5	
PBD 50 H 300	20	12	2517	202,13	200,76	172	-	86	120	45	20,5	
PBD 52 H 300	52	12	2517	210,21	208,84	185	-	86	120	45	20,5	
PBD 60 H 300	60	15	2517	242,55	241,18	217	-	86	120	45	20,5	
PBD 70 H 300	70	15	2517	282,98	281,61	264	-	86	120	45	20,5	
PBD 72 H 300	72	15	2517	291,06	289,69	264	-	86	120	45	20,5	
PBD 82 H 300	82	15	2517	331,49	330,12	312	-	86	120	45	20,5	
PBD 84 H 300	84	15	2517	339,57	338,20	312	-	86	120	45	20,5	
PBD 94 H 300	94	15	3030	380,00	378,63	357	-	86	146	76	5	
PBD 96 H 300	96	15	3030	388,08	386,71	357	-	86	146	76	5	

 Příklad označení - vzor objednávky: Řemenice **PBD 50 H 300**

Ozubené řemenice - systém TAPER LOCK

Profil H

rozteč zubů 1/2" (12.70 mm)

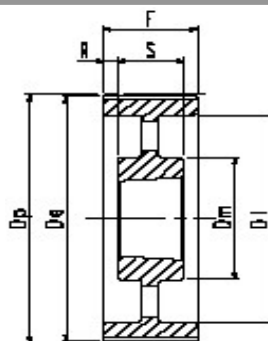

15

H 300 - pro řemen širě 3" (76.20 mm)

Označení řemenice	Počet zubů	Typ	Typ pouzdra	Dp (mm)	De (mm)	Di (mm)	Df (mm)	F (mm)	Dm (mm)	S (mm)	R (mm)	Materiál
PBD 106 H 300	106	15	3030	428,51	427,14	402	-	86	146	76	5	litina
PBD 116 H 300	116	15	3030	468,93	467,56	442	-	86	146	76	5	
PBD 118 H 300	118	15	3030	477,02	475,65	457	-	86	146	76	5	
PBD 120 H 300	120	15	3030	485,10	483,73	457	-	86	146	76	5	

Příklad označení - vzor objednávky: Řemenice **PBD 106 H 300**