

Ozubené řemenice Silent Sync

Blue

rozteč zubů 14 mm, šíře řemene 35 mm

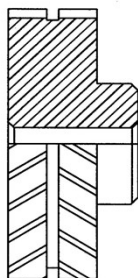

1

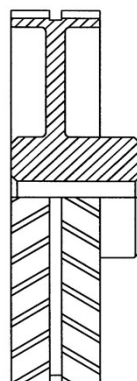

2

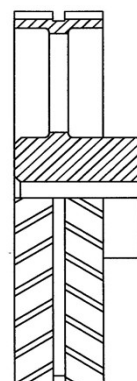

3

BLUE					
Označení řemenice	Počet zubů	Provedení řemenice	Roztečný průměr (mm)	Max. povol. průměr otvoru v náboji (mm)	Hmotnost (kg)
B - 28S - MPB	28	1	124,78	70	3,59
B - 30S - MPB	30	1	133,69	76	4,22
B - 32S - MPB	32	1	142,61	82	4,89
B - 34S - MPB	34	1	151,52	88	5,61
B - 36S - MPB	36	1	160,43	94	6,38
B - 38S - MPB	38	1	169,35	100	7,20
B - 40S - MPB	40	1	178,26	106	8,06
B - 43S - MPB	43	1	191,63	115	9,45
B - 45S - MPB	45	1	200,54	121	10,44
B - 48S - MPB	48	1	213,91	130	12,01
B - 50S - MPB	50	2	222,82	100	9,85
B - 56S - MPB	56	2	249,56	100	10,79
B - 60S - MPB	60	2	267,39	100	11,46
B - 63S - MPB	63	2	280,76	100	11,98
B - 71S - MPB	71	2	316,41	100	12,95
B - 75S - MPB	75	2	334,24	100	13,46
B - 80S - MPB	80	2	356,52	100	14,14
B - 90S - MPB	90	2	401,08	100	15,08
B - 112S - MPB	112	3	499,12	100	17,99
B - 140S - MPB	140	3	623,91	100	21,70
B - 168S - MPB	168	3	748,69	100	25,41
Průměr předvrtaného otvoru v náboji řemenice (mm):				25,4	

Ozubené řemenice Silent Sync

Green

rozteč zubů 14 mm, šíře řemene 52.5 mm

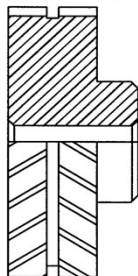

1

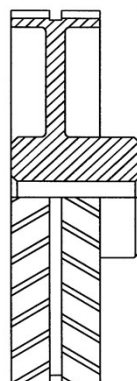

2

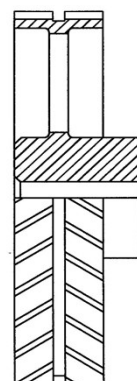

3

EAGLE Pd GREEN					
Označení řemenice	Počet zubů	Provedení řemenice	Roztečný průměr (mm)	Max. povol. průměr otvoru v náboji (mm)	Hmotnost (kg)
G - 28S - MPB	28	1	124,78	73	5,18
G - 30S - MPB	30	1	133,69	78	6,02
G - 32S - MPB	32	1	142,61	84	6,99
G - 34S - MPB	34	1	151,52	90	8,01
G - 36S - MPB	36	1	160,43	94	8,57
G - 38S - MPB	38	1	169,35	100	9,66
G - 40S - MPB	40	1	178,26	106	10,82
G - 43S - MPB	43	1	191,63	115	12,67
G - 45S - MPB	45	1	200,54	121	13,99
G - 48S - MPB	48	1	213,91	130	16,08
G - 50S - MPB	50	2	222,82	100	14,14
G - 56S - MPB	56	2	249,56	100	14,62
G - 60S - MPB	60	2	267,39	100	15,49
G - 63S - MPB	63	2	280,76	100	16,16
G - 71S - MPB	71	2	316,41	100	17,45
G - 75S - MPB	75	2	334,24	100	18,11
G - 80S - MPB	80	2	356,52	100	19,02
G - 90S - MPB	90	2	401,08	120	24,68
G - 112S - MPB	112	3	499,12	120	29,05
G - 140S - MPB	140	3	623,91	133	38,21
G - 168S - MPB	168	3	748,69	133	44,11
Průměr předvrtaného otvoru v náboji řemenice (mm):				25,4	

Ozubené řemenice Silent Sync

Orange

rozteč zubů 14 mm, šíře řemene 70 mm

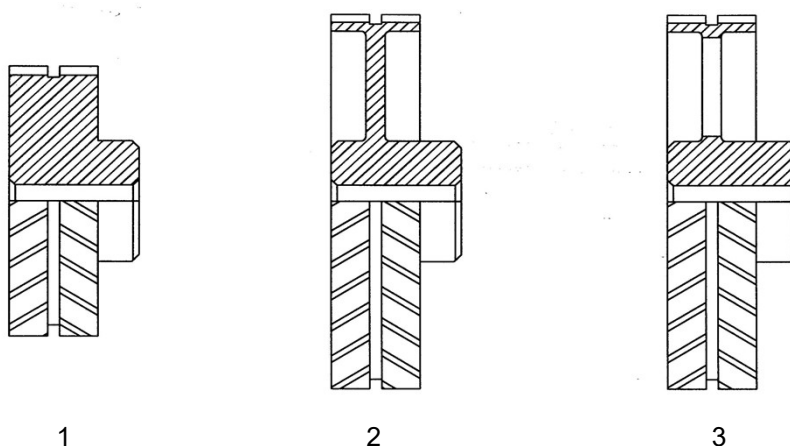

EAGLE Pd ORANGE					
Označení řemenice	Počet zubů	Provedení řemenice	Roztečný průměr (mm)	Max. povolený průměr otvoru v náboji (mm)	Hmotnost (kg)
O - 28S - MPB	28	1	124,78	73	6,41
O - 30S - MPB	30	1	133,69	78	7,50
O - 32S - MPB	32	1	142,61	84	9,21
O - 34S - MPB	34	1	151,52	90	10,56
O - 36S - MPB	36	1	160,43	95	11,93
O - 38S - MPB	38	1	169,35	101	13,46
O - 40S - MPB	40	1	178,26	107	15,07
O - 43S - MPB	43	1	191,63	116	15,95
O - 45S - MPB	45	1	200,54	122	17,60
O - 48S - MPB	48	1	213,91	131	20,24
O - 50S - MPB	50	1	222,82	137	22,06
O - 56S - MPB	56	1	249,56	153	28,00
O - 60S - MPB	60	2	267,39	100	19,51
O - 63S - MPB	63	2	280,76	100	20,34
O - 71S - MPB	71	2	316,41	100	21,94
O - 75S - MPB	75	2	334,24	120	28,11
O - 80S - MPB	80	2	356,52	120	29,00
O - 90S - MPB	90	2	401,08	133	34,94
O - 112S - MPB	112	3	499,12	133	40,78
O - 140S - MPB	140	3	623,91	147	52,95
O - 168S - MPB	168	3	748,69	147	60,78
Průměr předvrtaného otvoru v náboji řemenice (mm):				25,4	

Ozubené řemenice Silent Sync

Red

rozteč zubů 14 mm, šíře řemene 105 mm

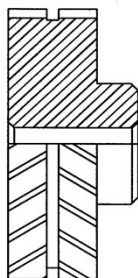

1

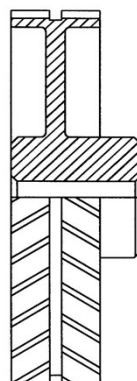

2

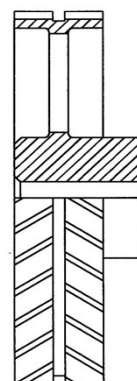

3

EAGLE Pd RED					
Označení řemenice	Počet zubů	Provedení řemenice	Roztečný průměr (mm)	Max. povol. průměr otvoru v náboji (mm)	Hmotnost (kg)
R - 28S - MPB	28	1	124,78	73	9,29
R - 30S - MPB	30	1	133,69	78	10,87
R - 32S - MPB	32	1	142,61	84	12,58
R - 34S - MPB	34	1	151,52	90	14,42
R - 36S - MPB	36	1	160,43	96	16,35
R - 38S - MPB	38	1	169,35	102	18,43
R - 40S - MPB	40	1	178,26	108	20,63
R - 43S - MPB	43	1	191,63	117	24,12
R - 45S - MPB	45	1	200,54	122	24,70
R - 48S - MPB	48	1	213,91	131	28,39
R - 50S - MPB	50	1	222,82	137	30,95
R - 56S - MPB	56	1	249,56	153	39,30
R - 60S - MPB	60	2	267,39	120	38,25
R - 63S - MPB	63	2	280,76	120	39,14
R - 71S - MPB	71	2	316,41	133	45,74
R - 75S - MPB	75	2	334,24	133	44,10
R - 80S - MPB	80	2	356,52	133	46,27
R - 90S - MPB	90	2	401,08	147	55,09
R - 112S - MPB	112	3	499,12	147	63,77
R - 140S - MPB	140	3	623,91	160	81,79
R - 168S - MPB	168	3	748,69	160	93,38
Průměr předvrtaného otvoru v náboji řemenice (mm):				25,4	